

INSTRUKCJA INSTALACJI

Uchwyt do telewizora

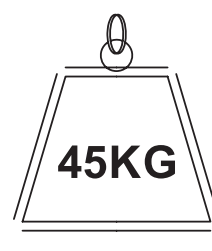
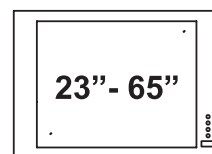
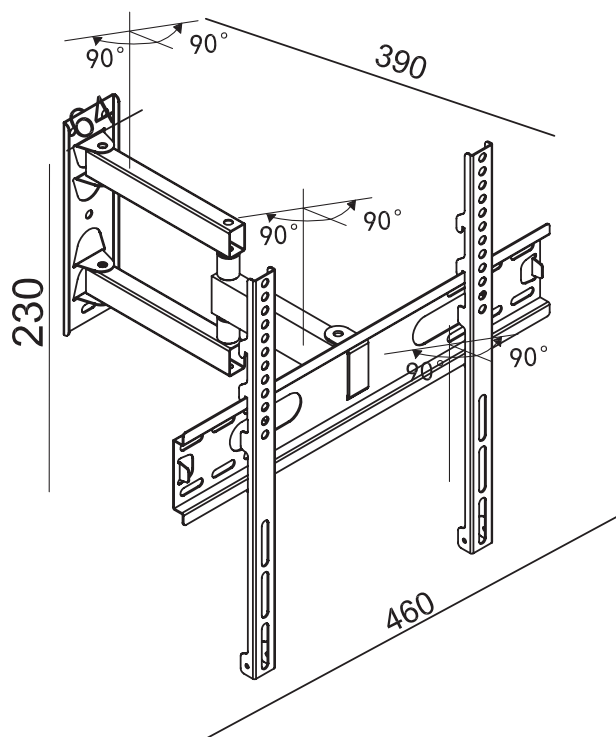

Przewidywany czas montażu przy użyciu odpowiednich narzędzi – **30 minut**

1



Ściana ceglana



Ściana drewniana

Ołówek

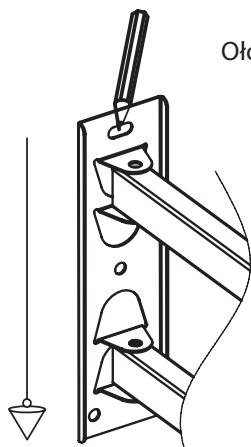

Umieść uchwyt montażowy pionowo na ścianie (patrz na rysunek), a następnie oznacz ołówkiem miejsce otworów do wywiercenia.

2

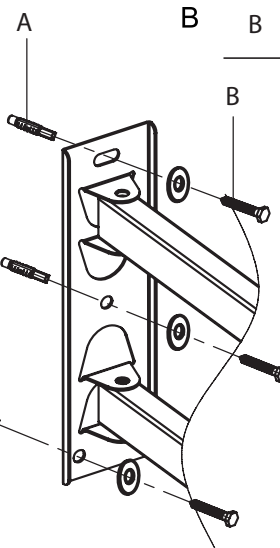







A		Ø10X50	4
B		ST6X60	4
		Ø18X8X2	4



W zaznaczonych miejscach wywierć otwory o rozmiarze Ø10 i głębokości co najmniej 60mm. Użyj części A i B, aby przymocować uchwyt do ściany.

3

C

	M5X10	4
	M5X25	4
	M6X10	4
	M6X25	4
	M4X45	4
	M8X45	4

D

	Ø14XØ5X1	4
	Ø16XØ6X1	4

E

	Ø12XØ6X12	4
---	-----------	---

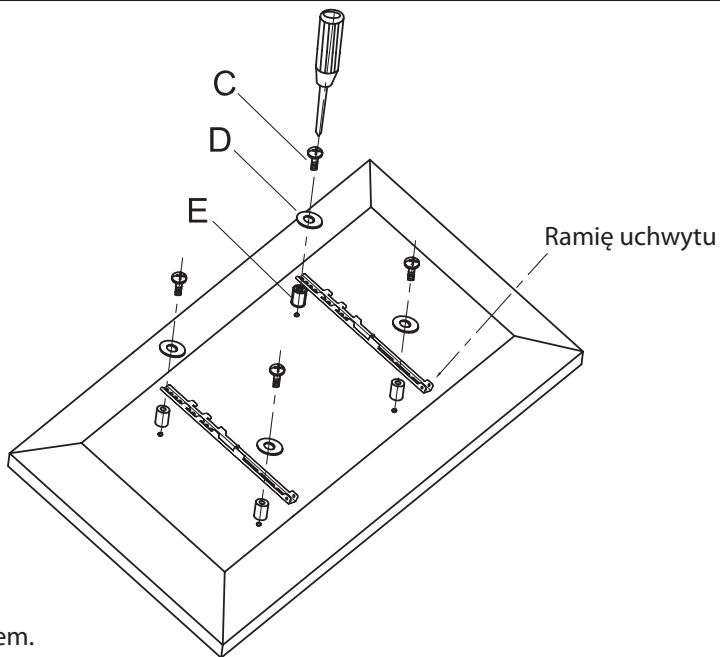

Wybierz odpowiednie narzędzia aby przymocować wsporniki, zgodnie ze schematem.

4

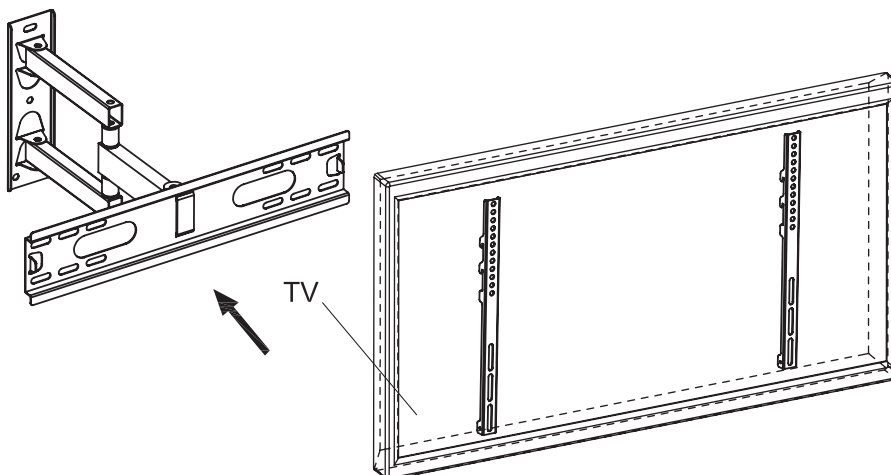

5

